

**TK-1B**

W108

WILLIAMS

**MONOSCOPE CAMERA**



**RADIO CORPORATION OF AMERICA**  
**ENGINEERING PRODUCTS DEPARTMENT CAMDEN, N. J.**

IB-36075



memo from

ROBERT M. WILSON

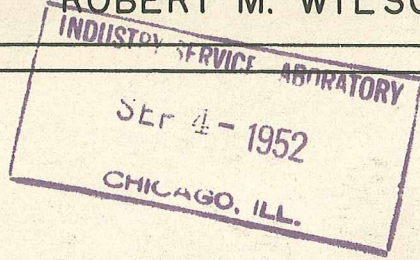

9-3-52

Ted

My hunch about RCAI  
worked. There is a TK-1B  
Manual which you may  
keep

Bob



*Jerry Williams*  
*RCA Feb 1970*

# TK-1B MONOSCOPE CAMERA

ES-26960-A

## INSTRUCTIONS

Copyright 1950  
RADIO CORPORATION OF AMERICA  
RCA Victor Division

Manufactured by  
RADIO CORPORATION OF AMERICA  
ENGINEERING PRODUCTS DEPARTMENT  
Camden, New Jersey, U. S. A.



# WARNING

THE VOLTAGES EMPLOYED IN THIS EQUIPMENT ARE SUFFICIENTLY HIGH TO ENDANGER HUMAN LIFE AND EVERY REASONABLE PRECAUTION HAS BEEN OBSERVED IN DESIGN TO SAFEGUARD THE OPERATING PERSONNEL. THE POWER SHOULD BE REMOVED COMPLETELY BEFORE CHANGING TUBES OR MAKING INTERNAL ADJUSTMENTS.

---

## FIRST AID IN CASE OF ELECTRIC SHOCK

1. PROTECT YOURSELF with dry insulating material.
2. BREAK THE CIRCUIT by opening the power switch or by pulling the victim free of the live conductor.

DON'T TOUCH VICTIM WITH YOUR BARE HANDS until the circuit is broken.

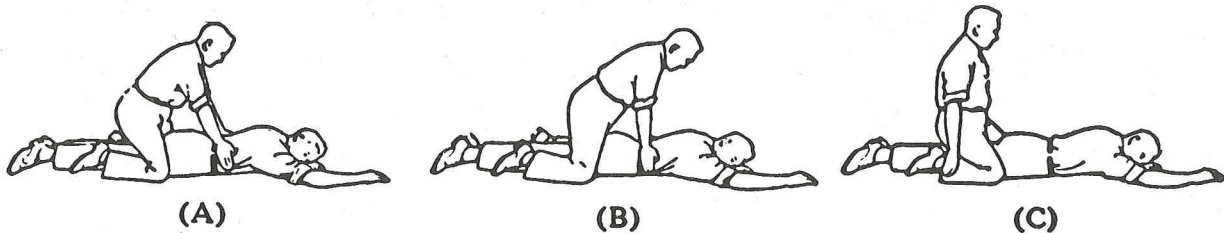

3. LAY PATIENT ON STOMACH, one arm extended, the other arm bent at elbow. Turn face outward resting on hand or forearm.
4. REMOVE FALSE TEETH, TOBACCO OR GUM from patient's mouth.
5. KNEEL STRADDLING PATIENT'S THIGHS. See (A).
6. PLACE PALMS OF YOUR HANDS ON PATIENT'S BACK with little fingers just touching the lowest ribs.
7. WITH ARMS STRAIGHT, SWING FORWARD gradually bringing the weight of your body to bear upon the patient. See (B).
8. SWING BACKWARD IMMEDIATELY to relieve the pressure. See (C).
9. AFTER TWO SECONDS, SWING FORWARD AGAIN. Repeat twelve to fifteen times per minute.
10. WHILE ARTIFICIAL RESPIRATION IS CONTINUED, HAVE SOMEONE ELSE:
  - (a) Loosen patient's clothing.
  - (b) Send for doctor.
  - (c) Keep patient warm.
11. IF PATIENT STOPS BREATHING, CONTINUE ARTIFICIAL RESPIRATION. Four hours or more may be required.
12. DO NOT GIVE LIQUIDS UNTIL PATIENT IS CONSCIOUS.



## TABLE OF CONTENTS

	Page No.
TECHNICAL SUMMARY .....	4
Electrical Characteristics .....	4
Tube Complement .....	4
Mechanical Specifications .....	4
EQUIPMENT .....	4
DESCRIPTION .....	5
General .....	5
Circuits .....	5
INSTALLATION .....	8
Installing Monoscope Tube .....	8
Connecting Cables .....	8
Initial Adjustments .....	9
OPERATION .....	10
Interpretation of Test Pattern .....	10
MAINTENANCE .....	10
PARTS LIST .....	12

## LIST OF ILLUSTRATIONS

Figure No.		
1	Block Diagram, Monoscope Camera (P-728972, sub 1) .....	6
2	Fundamental Damper Circuit (K-893491, sub 0).....	7
3	Horizontal Damper Circuit (M-445710, sub 1) .....	7
4	Picture Pattern, Monoscope Camera .....	11
5	Monoscope Camera, Front View — Panel Removed .....	16
6	Monoscope Camera, Rear View .....	17
7	Voltage and Waveform Chart .....	18
8	Schematic Diagram, Monoscope Camera (E-312332, sub 0) .....	19



## TECHNICAL SUMMARY

### ELECTRICAL CHARACTERISTICS

#### Input Requirements:

Horizontal Drive .....	-3.5 to -5 volts, 10% hor. cycle
Vertical Drive .....	-3.5 to -5 volts, 4% vert. cycle
Blanking Pulses .....	-3.5 to -5 volts, RMA std.
Synchronizing Signal (Optional) .....	-3.5 to -5 volts, RMA std.
Auxiliary Signal* .....	1.5 volts, max.
Impedance .....	75 ohms
Output Signal (2 identical outputs).....	1.5 volts video plus 0.5 volt sync., or 2 volts composite, white in positive direction. Impedance 75 ohms.

#### Power:

D. C. Requirement, Regulated.....	-3 volts (centering) and 300 ma at 280 volts
A. C. Requirement .....	110/120 volts, 50/60 cycles, 100 watts

\*Auxiliary signal is not amplified, only modified by optional addition of blanking and synchronizing pulses.

### TUBE COMPLEMENT

6 RCA Type 6AC7	3 RCA Type 6SN7GT	1 RCA Type 1B3GT/8016
3 RCA Type 6AG7	1 RCA Type 6V6GT	1 RCA Type 2F21
3 RCA Type 6SL7GT	1 RCA Type 6Y6G	1 RCA Type 991

For tube functions, refer to Figure 7.

### MECHANICAL SPECIFICATIONS

Height .....	17½ inches
Width .....	19 inches
Depth .....	11 inches
Weight .....	.55 pounds

### EQUIPMENT

The TK-1B Monoscope Camera is supplied as MI-26030-A and includes all tubes in place except the Monoscope tube. This tube, type 2F21, is shipped separately and carries the RCA reference number MI-26657. A square set of tubes may be ordered as MI-26679-A.

For necessary interconnections one 10-prong Jones plug, five coaxial connectors, and six 75-ohm coaxial terminations are supplied with the equipment. Cable required but not supplied is as follows:

- 1 Five-wire cable from the d-c power supply—2 wires for a-c connection, 2 wires for d-c voltage, and 1 wire for centering voltage.
- 1 Interconnecting cable for remote focus and gain controls (if used).
- Required number and length of 75-ohm cables for installation.

A d-c power source such as from the RCA Type 580-C Regulated Power Supply, MI-21523-B1, is required for the Monoscope Camera. Synchronizing pulses may be obtained from the RCA Type TG-1A generator, MI-26915.

## DESCRIPTION

### GENERAL

The Type TK-1B Monoscope Camera has been designed to produce a video signal of high and dependable quality for use with or without synchronizing pulses. The fixed pattern provided is suitable for checking resolution capabilities, low-frequency phase shift, contrast, and deflection linearity of other television studio equipment, as well as providing a modulating signal for transmitters. When the camera output is employed to modulate an r-f signal generator, the resultant signal may be used to check receiver performance. The Monoscope Camera utilizes a recessed type chassis designed for mounting in a standard 19-inch rack or cabinet.

Four paralleled connectors make it possible to feed the input signals through to other equipment without disturbing the camera circuits. Three other coaxial connectors provide for the camera output, and seven pin jacks on the chassis enable a rapid check to be made on all input and output signals.

A narrow panel near the lower part of the unit contains the eight most important operating controls while the chassis mounts five screwdriver adjustments. An interlock circuit removes all high voltage when the front panel is removed. A shorting plug clipped to the panel enables the interlock to be bypassed when required during servicing or test.

Low-plate voltage for the Monoscope Camera requires a source of 280 volts d-c at 300 ma; the high-voltage circuit in the camera requires 110/120 volts a-c, 50/60 cycles. A 10-prong Jones plug on the chassis provides for connecting these two circuits.

### CIRCUITS

#### *Monoscope Tube*

The basic operation of the Monoscope Camera is illustrated on the block diagram, Figure 1. Source of the picture signal is the Monoscope tube which contains a fixed pattern of carbon deposited on an aluminum plate. Advantage is taken of the different secondary emission characteristics of the aluminum and carbon pattern.

When the fixed pattern is scanned, electrons emitted are collected on an electrode which is in the form of a conductive coating on the tube. Al-

though this coating is a-c coupled to ground, it is at a positive potential with respect to the pattern. The picture signal, therefore, appears between the pattern plate and ground.

The high voltage circuit in the unit supplies the accelerating and focusing potentials for the scanning beam. Deflection of the beam is achieved magnetically by horizontal and vertical deflection yokes which fit over the neck of the tube. Sawtooth scanning currents are supplied to the yokes by horizontal and vertical deflection circuits in the unit. Driving pulses for the deflection circuits must be furnished by an external synchronizing generator.

#### *Vertical Deflection Circuit*

As shown on the overall schematic diagram, Figure 8, vertical driving pulses from the synchronizing generator are inserted at either of the two paralleled connectors, J7 or J8. Amplification of the driving pulses is obtained in one triode section of V14, while the second section is utilized as a sawtooth generator. "Height" is controlled by potentiometer R96 in the plate circuit of V14.

Both sections of sawtooth amplifier V13 are connected in cascade to increase the voltage to the proper vertical driving level for the output tube V12A. Transformer T2 couples V12A to deflection coil L8.

The grid and cathode of vertical feedback amplifier V11A are connected across R109 which is in series with the vertical deflection coil L8. Resistor R109 also connects to the center tap on VERT. CENT. potentiometer R131. Control R131 is part of the grid leak circuit of V11A and has effect over the entire raster.

#### *Horizontal Deflection Circuit*

Horizontal driving pulses are fed into either J9 or J10. These connectors are coupled to one section of V18 which is utilized as a horizontal driving pulse amplifier. The other section of V18 is used as a sawtooth generator, "width" being controlled by R116.

Output from V18 is fed through V17, and through T3 to the horizontal deflection coils L7 and damper tube V16. Tube V16 provides control of horizontal deflection linearity and maximum utilization of available power. Figure 2 illustrates the fundamental damper circuit while



AUXILIARY INPUT  
 2 VOLTS P TO P, WITH SYNC.  
 1.5 VOLTS P TO P, WITHOUT SYNC.

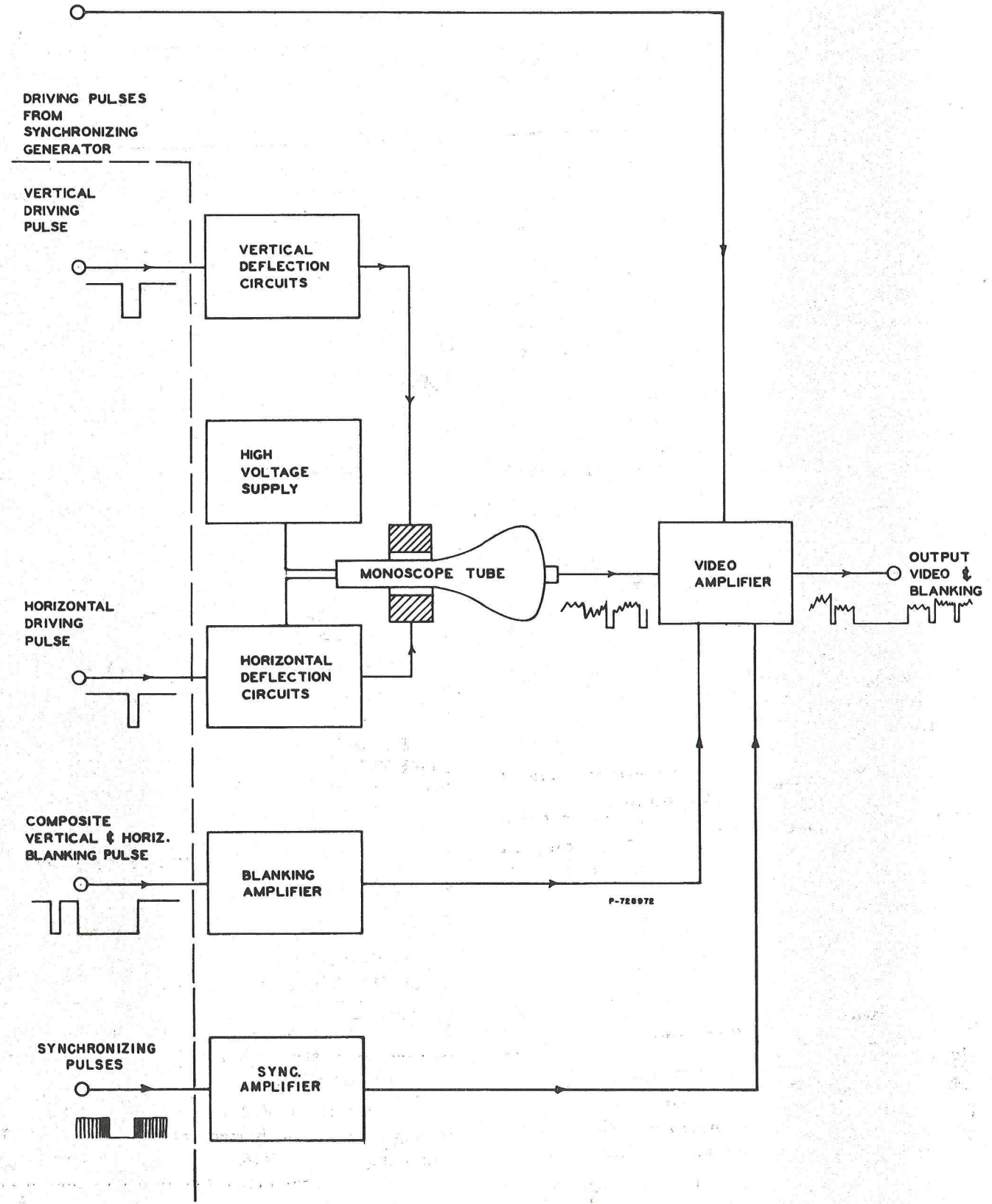

Figure 1—Block Diagram, Monoscope Camera

Figure 3 is an extraction from the overall schematic diagram. Potentiometers R127 and R126 are the HOR LIN A and HOR LIN B controls, respectively.

#### Blanking Amplifier

Blanking pulses through J5 or J6 are amplified by V9B and V7. By connecting the plate of V7 directly to the plate circuit of V2, the amplified blanking pulses are coupled to the video amplifier stages.

#### Video Amplifier

The seven-stage video amplifier, V1 to V8, is of the series-shunt peaked type. To compensate for the distributed capacity at the Monoscope output, a high-peaking circuit is added between V5 and V6. Frequency response of the other stages is essentially flat to 8 mc. The two output stages, V8 and V10, are identical.

GAIN control, R36, is connected into the screen grid circuit of V2 while R83, BRIGHTNESS control, functions to control black level in a linear clipper circuit. The "Transient Suppressor," R44, is set at about 1.5 volts above the screen voltage on V3.

The auxiliary signal input, J1 or J2, permits the optional mixing of special test signals with blanking and synchronizing pulses. Thus signals such as from a sweep generator or grating generator may be passed through a unity gain amplifier, V2 and V3. Blanking is added in the common plate load of V2 and V7, while optional synchro-

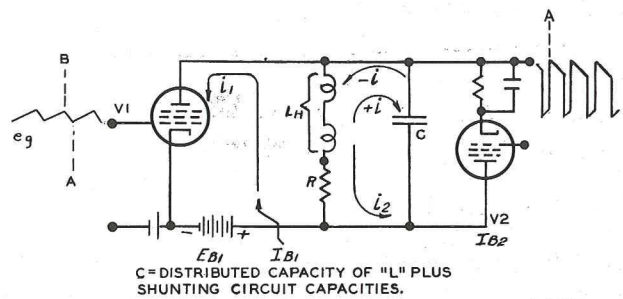

Figure 2—Fundamental Dampener Circuit

nizing pulses are added at the screen grid of V3. After mixing, the test signal then contains the necessary requisites for transmitter modulation. The AUX IN toggle switch, S1, on the chassis provides control of this circuit.

#### Synchronizing Amplifier

Synchronizing pulse inputs at J3 or J4 are passed through two amplifying stages, V9A and V12B, before insertion in the screen grid circuit of V3. Control of these pulses is provided by SYNC GAIN potentiometer R66, in the cathode circuit of V9A.

#### H. V. Power Supply

High voltage for the Monoscope tube, V20, is obtained from a power supply in the unit. Transformer T1 supplies heater voltages for all tubes as well as the high voltage for V20. An

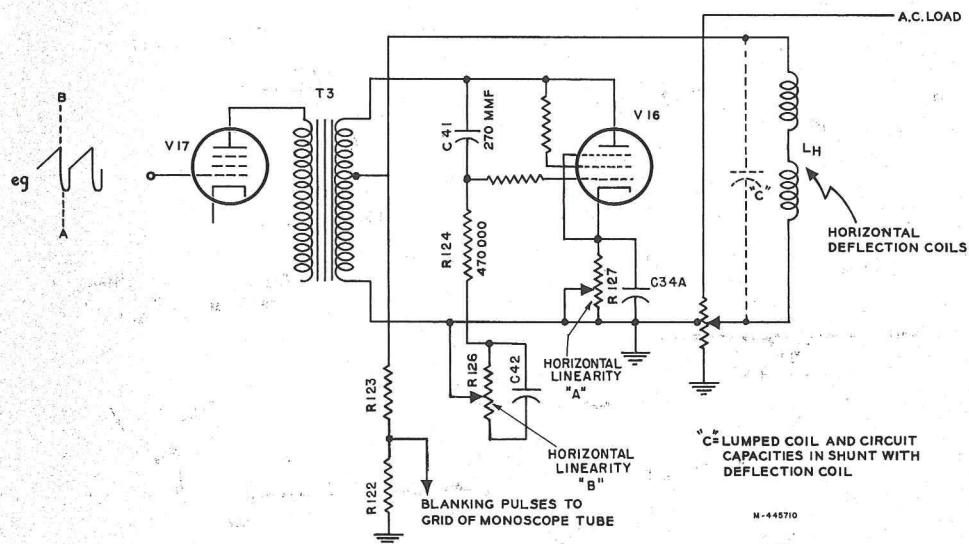

Figure 3—Horizontal Dampener Circuit



1B3GT/8016 tube, V15, serves as the high-voltage, half-wave rectifier.

The positive side of the high-voltage is grounded so the signal plate of the Monoscope will be at ground potential. FOCUS control R80 and BRIGHTNESS control R83 are part of the output bleeder which supplies the required Monoscope voltages.

Negative bias for the clipping action in V3 is also supplied by V15, while V11B serves as a voltage regulator. Fuse F1 and interlock S2 are connected in the primary circuit of T1.

#### Remote Operating Circuits

For remote focusing of the Monoscope tube,

a 2.5 megohm potentiometer may be connected to pin 6 of J15 as shown on Figure 8. This control may be utilized if the picture monitor is located at a distance from the Monoscope Camera.

Similarly, a 100,000-ohm potentiometer connected between pin 5 of J15 and ground may be utilized as a remote gain control.

#### Miscellaneous

Pins 10 and 12 of J15 are utilized for connecting the external d-c 280-volt supply required for low plate and screen voltages. The -3 volts centering potential is connected to pin 11, while pins 7 and 8 of J15 require 110/120, 50/60 cycle ac power connections.

## INSTALLATION

After unpacking, check the unit for damage incurred during shipment. Then remove the front panel and inspect all tubes to insure that they are firmly seated in their sockets.

Next, mount the unit in the rack or cabinet. Mounting screws are not supplied.

#### INSTALLING MONOSCOPE TUBE

To install the Monoscope tube, swing the hinged metal tube shield away from the chassis. Remove the top shield cover.

Insert the tube in the shield, rotating the tube so that the collector pin is accessible through the hole in the shield. Tighten the clamp on the lower end of the shield, to hold the tube in position.

Connect the red lead to the collector pin on the side of the tube.

Connect the black lead to the plate pin on the face of the tube. Position the wire so that it fits in the slot on the rim of the shield. Disconnecting the other end of this lead temporarily may facilitate making the connection. Be sure to reconnect it if removed.

Next replace the tube shield cover and swing the assembly back into place until locked by the pin and plug arrangement on the shield and chassis.

Attach the socket to the tube base, completing installation of this tube. Figure 5, the top chassis view, illustrates correct positioning of the leads to the tube.

#### CONNECTING CABLES

Two input taps are provided on the primary of transformer T1. If the measured line voltage ranges from 115 to 125 volts, the primary connec-

tion need not be changed since this is the as-shipped condition. If the line voltage falls within the 105 to 115 volt limits, the black wire with red tracer should be disconnected from the fuse receptacle and the black lead with yellow tracer connected in its place. Tape the end of the lead removed.

Connect a suitable cable to the Jones plug in socket J15. The connections to be made are as follows:

JACK J15	CIRCUIT
Pin 7, 8	110/120 volt, 50/60 cycle ac
Pin 10	280 volts dc, 300 ma, regulated
Pin 11	-3 volts dc
Pin 12	Ground
Pin 5	Remote gain (if required)
Pin 6	Remote focus (if required)

Since no a-c switch is contained in the Monoscope Camera, it is advisable to parallel the camera supply with the a-c source to the low voltage power supply which may be an RCA Type 580-C unit. In this manner the power supply switch will control the a-c to the camera, insuring that the deflection circuits will be operating while high voltage is on the Monoscope tube. This arrangement aids in preventing possible damage to the Monoscope tube.

Connect the driving, blanking, synchronizing pulse, and output cables as indicated adjacent to the seven coaxial jacks. Since an unterminated line causes reflections which may alter the shape of an incoming signal, use should be made of the 75-ohm line terminations supplied. These terminations plug into the auxiliary input connectors



and should be used when a cable is not terminated or not "looped" through to other equipment.

When used, connect a monitor to the MONITOR OUTPUT jack. Insertion or removal of the monitor plug will not affect the camera's signal output.

### INITIAL ADJUSTMENTS

Several initial adjustments must be made on the Monoscope Camera before routine operation. Since some of the controls are located on the chassis, the front panel must be removed during the following procedure, and the interlock short-circuited.

First, remove the interlock shorting plug from the front panel clips and place it in the interlock receptacle.

Set both remote controls, if used, at the mid-position.

Set the Monoscope GAIN control at mid-range.

Turn BEAM control counterlockwise to minimum.

Energize the low-voltage power supply and allow one minute for the equipment to warm up.

Make certain both vertical and horizontal driving pulses are present at the camera input jacks.

### DANGER

**AT ALL TIMES KEEP HANDS AWAY FROM THE PLATE LEAD OF THE HIGH-VOLTAGE RECTIFIER TUBE, V15. THIS LEAD IS AT A POTENTIAL OF 1250 VOLTS WITH RESPECT TO GROUND.**

Using the monitor oscilloscope as an indicator, set the blanking voltage to the desired amplitude by means of the BRIGHTNESS control. Adjust the raster in the monitor kinescope for the standard 4-to-3 aspect ratio.

Turn up the BEAM control until a picture appears on the monitor kinescope.

If the picture is rotated with respect to the raster, it may be aligned by loosening the two thumbscrews which hold the yoke against the Monoscope tube shield, and rotating the yoke.

Adjust for best focus with FOCUS control.

Adjust WIDTH, HEIGHT, VERT. CENT., and HOR. CENT. controls so that the picture in the monitor kinescope completely fills the raster.

Controls R126 and R127 are horizontal deflection linearity adjustments. H. LIN. A control, R127, should be set in the vicinity of from one-half to three-quarters maximum clockwise rotation. H. LIN. B control, R126, adjusts the scanning distribution on the righthand side of the picture. By careful adjustment of these controls a high degree of horizontal linearity can be achieved. Variable resistance R108, V. LIN., controls the vertical scanning linearity. These three screwdriver controls are mounted on the chassis and are indicated on Figure 5.

Synchronizing pulse height is controlled by SYNC. GAIN control R66, while R83, BRIGHTNESS control, enables the black level to be adjusted. These two screwdriver controls are also pointed out on Figure 5. If necessary to adjust the TRANSIENT SUPP. potentiometer, measure the voltage from the control arm to ground and set it for a potential approximately 1.5 volts above the screen voltage on V3.

Deflection linearity may be checked by measuring the spacing between the horizontal and vertical cross lines in the Monoscope pattern, Figure 4. The dashed lines in each wedge also serve as the center lines in this cross line pattern.

Linearity may be established independently of the viewing monitor by use of a grating generator such as the RCA Type WA-3A unit. The grating generator signal is simply connected to the AUX IN jack on the camera. Then, to mix the generator signal with the Monoscope pattern, temporarily disconnect the lead from the contact on S1 to ground and connect it to pin 3 or 5 of the socket for V2. Switch S1 should remain in the OFF position for this operation. After the linearity adjustment the lead should be reconnected to ground.

Using the monitor oscilloscope as an indicator, the blackest part of the picture signal should now be brought down to the blanking level. It is well to keep the beam intensity as high as possible in order to achieve the maximum signal-to-noise ratio in the video amplifier. Care should be taken however not to use too high a beam intensity since this causes enlargement of the beam with consequent loss in resolution.

After making all necessary adjustments, the auxiliary interlock plug should be removed from the receptacle and replaced in its holder on the front panel. Secure the front panel to the chassis.



## OPERATION

To operate the Monoscope Camera throw the power switch on the low voltage rectifier unit to the "ON" position. After the required warm-up period it may be necessary to make some slight readjustments of the gain, focus, and scanning controls. These panel controls will have to be re-adjusted from time to time as the tubes age.

### INTERPRETATION OF TEST PATTERN

In Figure 4, the test pattern of the RCA type 2F21 Monoscope tube is illustrated. The outside diameter of the large circle is three-fourths the pattern width. Therefore, when the deflection is adjusted so as to give a true, or undistorted form to this circle, the standard aspect ratio of 4-3 is established.

The five sets of vertical and horizontal resolution wedges are calibrated in number of lines resolution, i.e. the numbers indicate the total number of alternate black and white lines of equal width which can be contained in the height of the picture. Resolution lines are of equal width in both horizontal and vertical directions. Hence, the total number of lines which can be contained in the width of the picture is greater than the number contained in the height by a factor equal to the aspect ratio (1.33).

The dashed center line of each wedge indicates the calibration point of the value adjacent to it. The calibrations 20, 30, etc., multiplied by 10

indicate the number of lines resolution. The point on the vertical wedges where distinction between individual lines just disappears, indicates the horizontal resolution of the system or equipment under test.

In the case of the horizontal wedges, vertical resolution is indicated by the calibration of the point where separation between lines just becomes indistinguishable. The principal set of wedges in the central part of the pattern, as well as those in each of the four corners, provides an indication of the quality focus. This applies especially to the corner wedges where defocusing is most likely to prevail.

The diagonal wedges simulate a density range extending from black towards white. With the brightness adjusted so that the innermost portion is black, or 100 percent, the remaining three sections of each wedge are respectively 75, 50, and 25 per cent of black.

Thin line grids extending over the pattern provide an additional check on the horizontal and vertical deflection linearity. The diagonal bars indicate the boundaries of a section which is one-half the overall pattern width. The horizontal bars beneath the small circle vary logarithmically in length. The amount of streaking following the end of the bar in the change from black to white, indicates the quality of the low-frequency response of the circuits under test.

## MAINTENANCE

### WARNING

**HIGH VOLTAGES INJURIOUS TO LIFE ARE PRESENT IN THE UNIT. USE GREAT CARE IN MEASURING TUBE VOLTAGES. HEAVY, WELL-INSULATED TEST PROBES SHOULD BE USED IN CONJUNCTION WITH A METER CAPABLE OF MEASURING AT LEAST 1500 VOLTS.**

Little attention is required to keep the Monoscope Camera in good working condition. Periodic inspections should be started dating from the time the unit is placed in operation. These inspection periods should be no longer than thirty days apart. During these inspections the unit should be cleaned and dusted thoroughly. All tubes should be checked. Any tube showing weak or sluggish emission should be replaced with a tube known to be good.

In the event faulty operation does occur, a

typical voltage and waveform chart is supplied on Figure 7. When measuring tube voltages any measurement plus or minus twenty per cent of the typical voltage readings is an indication of a fault in the circuit being measured.

The high voltage supply has a 1.5 ampere fuse, F1, in series with one side of the power source. Under no circumstance replace this fuse with one having a higher current rating. In the event a replaced fuse burns out, ascertain and clear the fault in the unit before inserting another.

Seven chassis pin jacks, labeled BLANK, AUX, PIX, V. DRIVE, SYNC, H. DRIVE, and MON., enable these circuits to be tested rapidly from the front of the unit. In addition these test jacks make it unnecessary for any external cables to be removed. Symbol numbers of the jacks are J2, 12, 14, 16, 17, 18, and 20.



Figure 4—Picture Pattern, Monoscope Camera

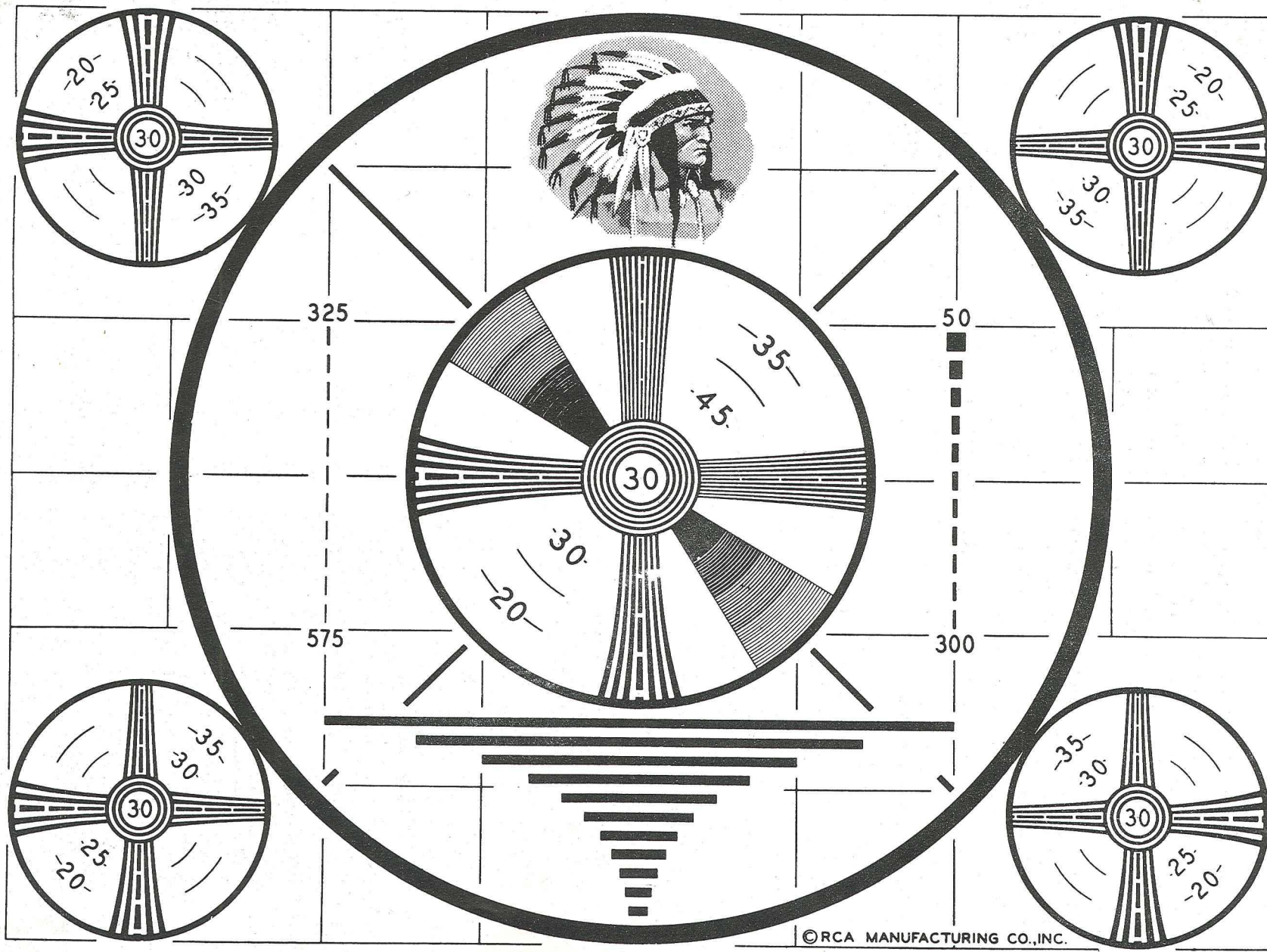

©RCA MANUFACTURING CO.,INC.



## PARTS LIST

When ordering replacement parts, please give RCA Stock Number, Symbol Number, Description, and Drawing Number will be helpful in further identifying the desired part and should be given when no Stock Number is shown in the following list.

The part which will be supplied against an order for a replacement, item may not be an exact duplicate of the original part, however, it will be

a satisfactory replacement, differing only in minor mechanical or electrical characteristics. Such differences will in no way impair the operation of the equipment.

Symbol Numbers with suffix letters may not be shown on the schematic. They are used for relating the parts to the main item of which they are components.

### MONOSCOPE CAMERA

SYMBOL No.	DESCRIPTION	DRAWING No.	STOCK No.
C1	Capacitor, 0.25 mf, 600 volts.....	K-8887706-12	59751
C2	Capacitor, 1000-1000 mf, 15 volts.....	B-442900-40	59757
C2A/B	Capacitor, part of C2		
C3	Capacitor, 80-10 mf, 400 volts.....	M-442900-33	59758
C3A/B	Capacitor, part of C3		
C4	Capacitor, 0.047 mf, 400 volts.....	C-735715-171	73553
C5	Not Used		
C6	Capacitor, same as C4		
C7	Capacitor, 20-10-10-10 mf, 450 volts.....	B-442900-30	59759
C7A/B/C and D	Capacitor, part of C7		
C8	Capacitor, same as C4		
C9	Capacitor, variable, 7-45 mmf.....	K-868903-3	54221
C10	Capacitor, same as C3		
C10A/B	Capacitor, part of C10		
C11	Capacitor, same as C4		
C12, C13	Capacitor, 330 mmf, 500 volts.....	P-727851-135	59484
C14	Capacitor, 0.47 mf, 400 volts.....	C-737818-96	59512
C15	Capacitor, same as C12		
C16	Capacitor, 20-20 mf, 450 volts.....	M-95695-39	34889
C16A/B	Capacitor, part of C16		
C17	Capacitor, same as C14		
C18	Capacitor, same as C16		
C19, C20	Capacitor, 1 mf, 600 volts.....	K-8887706-14	45807
C21	Capacitor, 0.22 mf, 400 volts.....	C-735718-179	74957
C22	Capacitor, same as C3		
C22A/B	Capacitor, part of C22		
C23	Capacitor, same as C21		
C24	Capacitor, same as C16		
C25	Capacitor, 8200 mmf, 1600 volts.....	C-735715-462	73821
C26	Capacitor, 1 mf, 1500 volts.....	K-984629-123	58481
C27	Capacitor, 2 mf, 1000 volts.....	K-984629-113	59760
C28	Capacitor, same as C26		
C29, C30, C31	Capacitor, 0.1 mf, 600 volts.....	C-735715-275	73557
C32, C33	Capacitor, same as C21		
C34	Capacitor, 0.5-0.5 mf, 400 volts.....	K-984680-417	56913
C34A/B	Capacitor, part of C34		
C35	Capacitor, same as C29		
C36, C37	Capacitor, 0.01 mf, 600 volts.....	C-735715-263	73565
C38	Capacitor, 270 mmf, 500 volts.....	P-727851-133	59483
C39	Capacitor, same as C36		
C40	Capacitor, same as C34		
C40A/B	Capacitor, part of C40		
C41	Capacitor, same as C38		
C42	Capacitor, same as C36		
C43	Capacitor, same as C29		
C44	Capacitor, same as C12		
F1	Fuse, 1.5 amperes.....	K-55544-2	2725
J1	Connector, jack.....	P-255223-1	51800
J2	Jack, tip.....	K-845648-1	18348
J3 to J11	Connector, same as J1		
J12	Jack, same as J2		
J13	Connector, same as J1		
J14	Jack, same as J2		
J15	Connector.....	P-727969-11	51928

SYMBOL No.	DESCRIPTION	DRAWING No.	STOCK No.
J16, J17, J18	Jack, same as J2		
J19	Connector, receptacle	M-445813-4	54890
J20	Jack, same as J2		
L1	Coil	P-739772-505	51906
L1A/B	Coil, part of L1		
L2	Coil, same as L1		
L2A/B	Coil, part of L2		
L3	Coil	P-739772-506	51907
L3A/B	Coil, part of L3		
L4	Coil, same as L3		
L4A/B	Coil, part of L4		
L5	Coil, same as L3		
L5A/B	Coil, part of L5		
L6	Coil, reactor	M-901919-1	51909
L7	Coil, assembly	K-8883411-501	54604
L8	Coil, deflecting yoke	P-727966-501	51913
P1	Connector, plug	K-252868-1	66344
P2	Not Used		
P3	Connector, same as P1		
P4	Not Used		
P5	Connector, same as P1		
P6	Not Used		
P7	Connector, same as P1		
P8	Not Used		
P9	Connector, same as P1		
P10 to P14	Not Used		
P15	Connector, plug	P-727969-12	51929
P16 to P18	Not Used		
P19	Connector, UG-260/U	M-427992-501	56153
R1	Resistor, 100,000 ohms, 1 watt	K-90496-86	72635
R2	Resistor, 100,000 ohms, 1/2 watt	K-82283-86	3252
R3	Resistor, 100 ohms, 1/2 watt	K-82283-50	34765
R4	Resistor, 150 ohms, 1/2 watt	K-82283-52	30880
R5	Resistor, 56,000 ohms, 1 watt	K-90496-83	17440
R6	Resistor, same as R3		
R7	Resistor, 10,000 ohms, 1/2 watt	K-82283-74	3078
R8	Resistor, 1500 ohms, 1/2 watt	K-82283-64	30654
R9	Resistor, 10,000 ohms, 1 watt	K-90496-74	71914
R10	Resistor, 470,000 ohms, 1/2 watt	K-82283-94	30648
R11	Resistor, same as R3		
R12	Resistor, same as R4		
R13	Resistor, same as R5		
R14	Resistor, 6800 ohms, 1/2 watt	K-82283-72	14659
R15	Resistor, same as R8		
R16	Resistor, 220 ohms, 1 watt	K-90496-54	39049
R17	Resistor, same as R10		
R18	Resistor, same as R3		
R19	Resistor, 82 ohms, 1/2 watt	K-82283-49	13961
R20	Resistor, 18,000 ohms, 1 watt	K-90496-77	18757
R21	Resistor, 560 ohms, 1 watt	K-90496-59	38884
R22	Resistor, 120,000 ohms, 1 watt	K-90496-87	72636
R23	Resistor, 680 ohms, 1/2 watt	K-82283-60	12262
R24	Resistor, same as R4		
R25	Resistor, same as R5		
R26	Resistor, 5600 ohms, 1/2 watt	K-82283-71	30734
R27	Resistor, 1200 ohms, 1/2 watt	K-82283-63	30731
R28	Resistor, 5600 ohms, 1 watt	K-90496-71	38886
R29	Resistor, same as R10		
R30	Resistor, same as R3		
R31	Resistor, 47 ohms, 1 watt	K-90496-46	45884
R32	Resistor, 33 ohms, 1/2 watt	K-82283-44	30789
R33	Resistor, 220 ohms, 1/2 watt	K-82283-54	5201
R34	Resistor, same as R5		
R35	Resistor, same as R1		
R36	Resistor, variable, 100,000 ohms	M-433196-4	51924
R37	Resistor, 2200 ohms, 1/2 watt	K-82283-66	34767
R38	Resistor, 910 ohms ±5%, 1 watt	K-90496-158	59761
R39	Resistor, 470,000 ohms, 1 watt	K-90496-94	72521
R40	Resistor, same as R3		
R41	Resistor, same as R4		
R42	Resistor, 33,000 ohms, 1 watt	K-90496-80	38895
R43	Resistor, 10,000 ohms, 2 watts	K-99126-74	44294
R44	Resistor, variable, 5000 ohms	M-433196-18	52009
R45	Resistor, 15,000 ohms, 2 watts	K-99126-76	68935
R46	Resistor, 8200 ohms, 1/2 watt	K-82283-73	14250



SYMBOL No.	DESCRIPTION	DRAWING No.	STOCK No.
R47	Resistor, 560 ohms, 1/2 watt	K-82283-59	5164
R48	Resistor, 27,000 ohms, 2 watts	K-99126-79	44213
R49	Resistor, 560,000 ohms, 1/2 watt	K-82283-95	30653
R50	Resistor, same as R3		
R51	Resistor, same as R19		
R52	Resistor, same as R3		
R53	Resistor, 18,000 ohms, 2 watts		
R54	Resistor, non-inductive, 3000 ohms, 5 watts	K-99126-77	39158
R55	Resistor, same as R2	M-443853-22	51629
R56	Resistor, same as R49		
R57	Resistor, 10 ohms, 1/2 watt		
R58	Resistor, 1000 ohms, 1 watt	K-82283-38	34761
R59	Resistor, same as R42	K-90496-62	71916
R60	Resistor, 560,000 ohms, 1 watt		
R61	Resistor, 47 ohms, 1/2 watt	K-90496-95	32726
R62	Resistor, 47,000 ohms, 1 watt	K-82283-46	30732
R63	Resistor, same as R1	K-90496-82	71988
R64	Resistor, same as R49		
R65	Resistor, 180 ohms, 1/2 watt		
R66	Resistor, variable, 500 ohms	K-82283-53	30618
R67	Resistor, 470 ohms, 1 watt	C-737829-5	59762
R68	Resistor, 1 megohm, 1/2 watt	K-90496-58	37278
R69	Resistor, 820,000 ohms, 1/2 watt	K-82283-98	30652
R70	Resistor, same as R3	K-82283-97	30161
R71	Resistor, same as R19		
R72	Resistor, same as R53		
R73	Resistor, same as R54		
R74	Resistor, same as R2		
R75	Resistor, 330,000 ohms, 1 watt		
R76	Resistor, variable, 50,000 ohms	K-90496-92	38892
R77	Resistor, 1.2 megohms, 1 watt	M-433196-5	51944
R78	Resistor, 1 megohm, 1 watt	K-90496-99	43017
R79	Resistor, same as R22	K-90496-98	71993
R80	Resistor, same as R36		
R81	Resistor, 150,000 ohms, 1 watt		
R82	Resistor, 180,000 ohms, 1 watt	K-90496-88	31895
R83	Resistor, variable, 10,000 ohms	K-90496-89	12356
R84	Resistor, 8200 ohms, 1 watt	M-433196-6	68833
R85	Resistor, 1200 ohms, 1 watt	K-90496-73	38888
R86	Resistor, 330,000 ohms, 1/2 watt	K-90496-63	38896
R87	Resistor, same as R2	K-82283-92	14983
R88, R89	Resistor, 15 ohms, 1/2 watt		
R90	Resistor, same as R68	K-82283-40	11565
R91	Resistor, 470 ohms, 1/2 watt		
R92	Resistor, same as R57	K-82283-58	30499
R93	Resistor, same as R68		
R94	Resistor, 22,000 ohms, 1 watt		
R95	Resistor, 2.2 megohms, 1/2 watt	K-90496-78	71989
R96	Resistor, same as R76	K-82283-102	30649
R97	Resistor, same as R1		
R98, R99	Resistor, 820 ohms, 1/2 watt		
R100	Resistor, same as R68	K-82283-61	30158
R101	Resistor, same as R43		
R102	Resistor, same as R9		
R103	Resistor, 470,000 ohms, 1/2 watt		
R104	Resistor, same as R58	K-82283-94	30648
R105	Not Used		
R106	Resistor, same as R16		
R107	Resistor, same as R1		
R108	Resistor, variable, 500,000 ohms		
R109	Resistor, 10 ohms, 1 watt	M-433196-30	52444
R110	Resistor, same as R68	K-90496-38	69640
R111, R112	Resistor, same as R57		
R113	Resistor, same as R2		
R114	Resistor, same as R94		
R115	Resistor, same as R5		
R116	Resistor, same as R76		
R117	Resistor, 47,000 ohms, 1/2 watt		
R118	Resistor, 270,000 ohms, 1 watt	K-82283-82	30787
R119	Resistor, same as R103	K-90496-91	19232
R120	Resistor, 390 ohms, 2 watts		
R121	Resistor, 100 ohms, 1 watt	K-99126-57	51212
R122	Resistor, 6800 ohms, 1 watt	K-90496-50	31215
R123	Resistor, same as R62	K-90496-72	38887
R124	Resistor, same as R103		
R125	Resistor, same as R3		

SYMBOL No.	DESCRIPTION	DRAWING No.	STOCK No.
R126	Resistor, variable, 2.5 megohms	M-427471-33	54159
R127	Resistor, variable, 2000 ohms	M-433196-17	52011
R128	Resistor, same as R3		
R129	Resistor, 2200 ohms, 1 watt	K-90496-66	71991
R130, R131	Resistor, variable, 20 ohms	M-433196-37	54416
S1	Switch, DPDT	M-95559-5	93263
S2A	Switch, interlock	K-99119-1	54591
S2B	Plug, interlock switch	K-99119-2	54592
T1	Transformer, power	M-901918-2	59763
T2	Transformer, vertical output	K-895383-1	51910
T3	Transformer, horizontal output	M-901813-1	51911
X1 to X18	Socket	K-99390-1	54414
X19	Socket	K-837884-2	43163
X20	Socket	K-856956-9	54160
Y1, Y2	Crystal, 1N48		54374
XF1	Socket, fuse	K-99088-1	58933
<b>MISCELLANEOUS</b>			
	Mounting plate, steel, for capacitor C6	K-85559-2	
	Mounting plate, steel, for capacitors C2, C3, C7, C10, C22	K-85559-3	
	Mounting plate, phenolic, for capacitors C18, C24	K-85558-2	28452
	Shield Assembly, monoscope	T-618751-501	51989
	Knob, for R36, R76, R80, R83, R96, R116, R130 R131	P-712336-507	30075
	Termination, coaxial	K-895438-501	54256



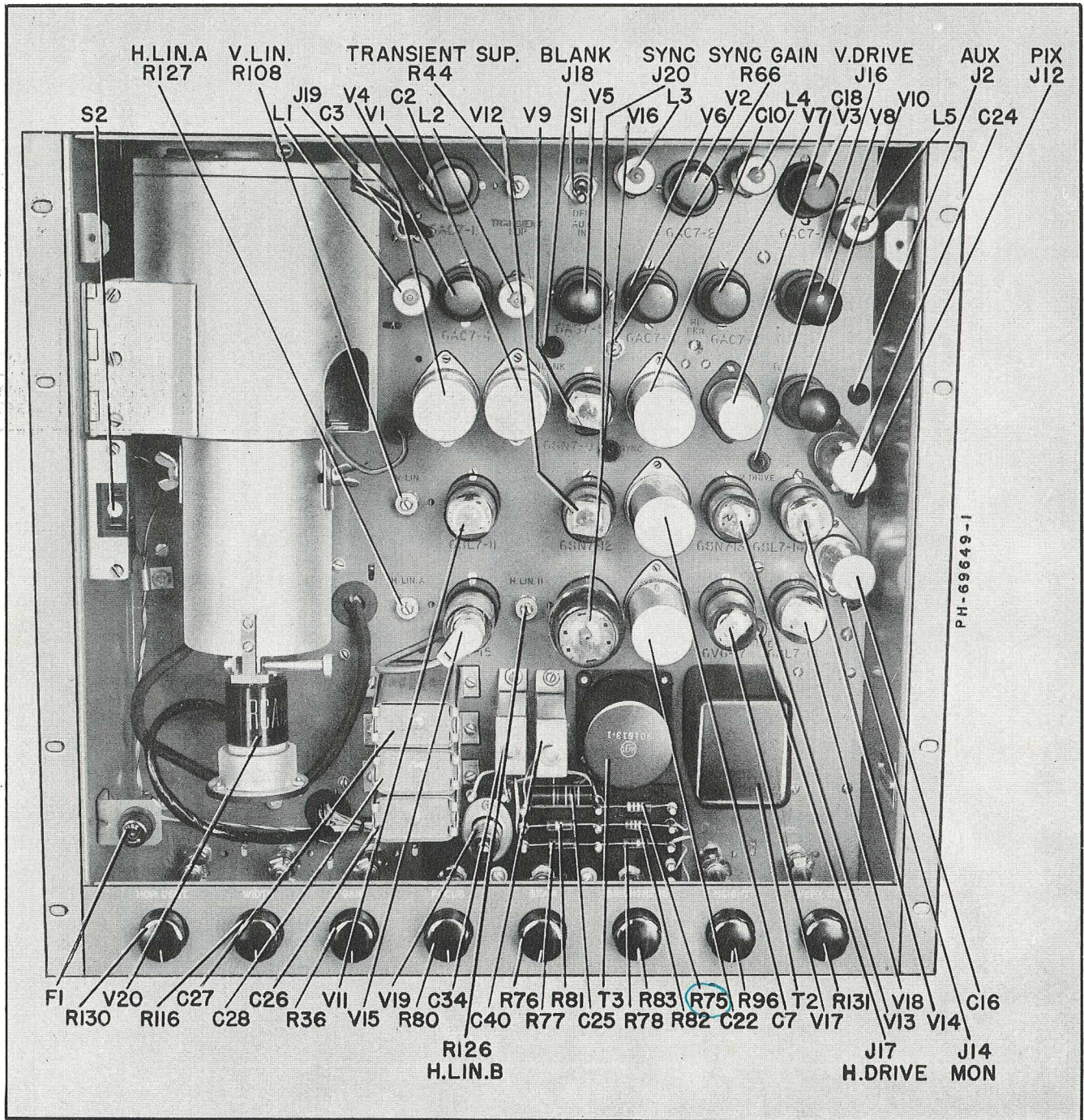

Figure 5—Monoscope Camera, Front View



160000

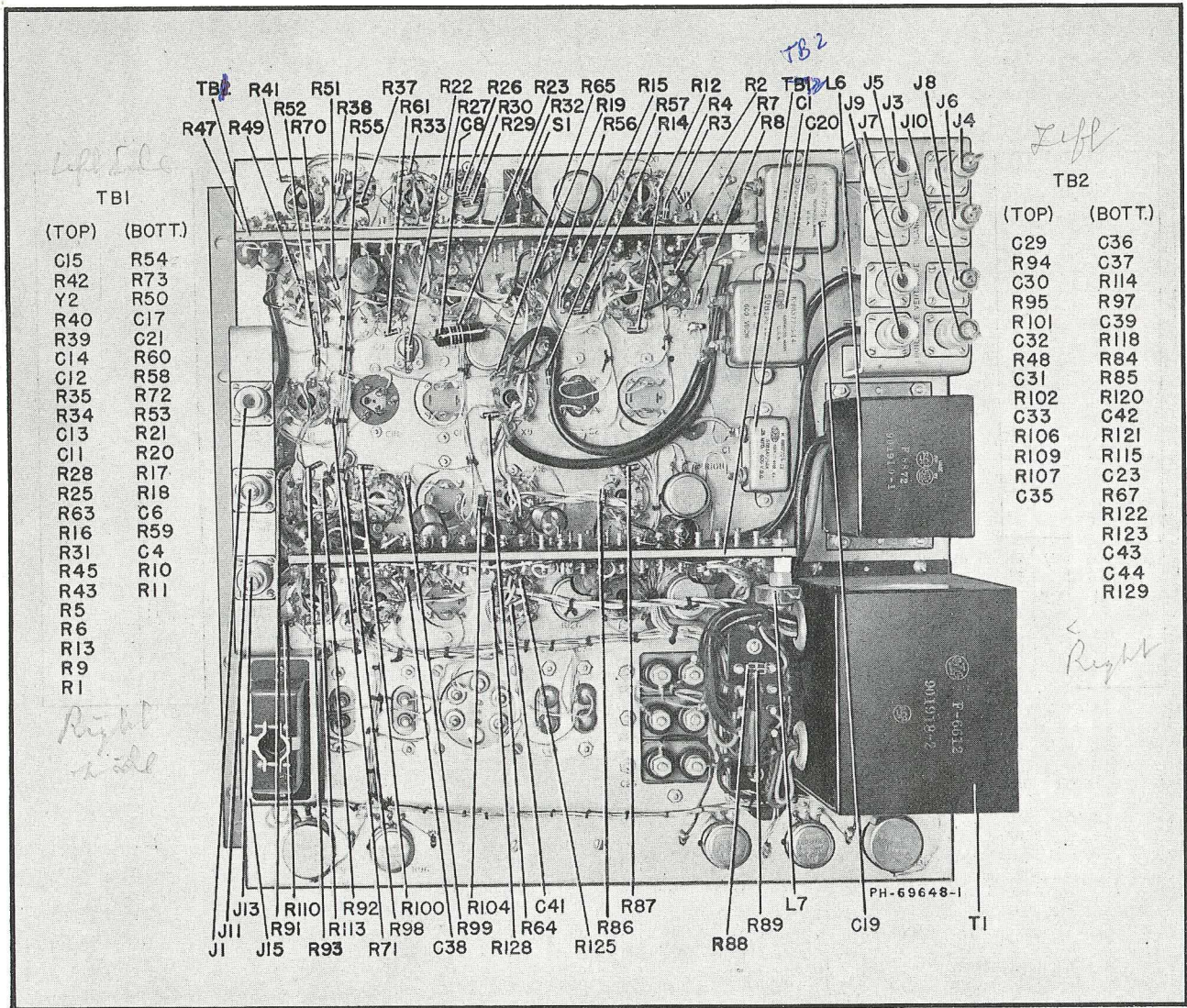

Figure 6—Monoscope Camera, Rear View.



TK-1B MONOSCOPE CAMERA

TUBE			GRID				PLATE				CATHODE				SCREEN	
SYMBOL	RCA TYPE	FUNCTION	PIN	VOLTAGE		WAVEFORM	PIN	VOLTAGE		WAVEFORM	PIN	VOLTAGE		WAVEFORM	PIN	VOLTAGE
				DC	AC*			DC	AC*			DC	AC*			DC
V1	6AC7	VIDEO AMP.	4	0			8	168			5	1.7		6	163	
V2	6AC7	VIDEO AMP.	4	0	1.0		8	275	9.6		5	2.2		6	155	
V3	6AC7	VIDEO AMP.	4	-2.5	9.6		8	160	6.3		5	1.25	2.0	6	160	
V4	6AC7	VIDEO AMP.	4	0			8	268			5	2		6	165	
V5	6AG7	VIDEO AMP.	4	0	3.0		8	270	5.0		5	2.9	3.0	6	152	
V6	6AC7	VIDEO AMP.	4	0			8	220	1.0	SAME AS GRID V2	5	1.9	0	6	145	
V7	6AC7	BLANKING AMP.	4	-2.4	7.0		8	275	9.6		5	0.15	0.7	6	70	
V8	6AG7	VIDEO OUTPUT	4	0	5.5		8	200	2.0		5	2.9	3.2	6	160	
V9A	1/2 6SN7	SYNC. AMP.	1	0	4.7		2	281	2.3		3	1.1	3.0	-	-	
V9B	1/2 6SN7	BLANKING AMP.	4	-1.1	3.5		5	208	7.0		6	0.03	0.08	-	-	
V10	6AG7	VIDEO OUTPUT	4	0	5.5	SAME AS V8	8	200	2.0	SAME AS V8	5	2.8	3.2	6	160	
V11A	1/2 6SL7	VERT. FEEDBACK AMP.	1	-1.4	0.08		2	189	2.9		3	-0.8	0.65	-	-	
V11B	1/2 6SL7	REGULATOR, H. V.	4	-0.6	0.1		5	95	8.0		6	0	0	-	-	
V12A	1/2 6SN7	VERT. OUTPUT	1	0	18		2	268	85		3	9	10	-	-	
V12B	1/2 6SN7	SYNC. AMP.	4	155	2.9		5	285	0		6	165		-	-	
V13A	1/2 6SN7	1st VERT. S. T. AMP.	1	0.05	1.4		2	189	2.9		3	5	1.2	-	-	
V13B	1/2 6SN7	2nd VERT. S. T. AMP.	4	0	2.9		5	209	17.5		6	5.9	1.3	-	-	
V14A	1/2 6SL7	VERT. DRIVE AMP.	1	0	4.0		2	138	30		3	4.2	1.3	-	-	
V14B	1/2 6SL7	VERT. DISCHARGE	4	-26	30		5	0.1	1.4		6	0		-	-	
V15	1B3GT	H. V. RECTIFIER	-	-			CAP	1250			2,7	95	8.0	-	-	
V16	6Y6G	HOR. DAMPER	5	-72	520		3	-3.3	720		8	6	1.2	4	-3.3	
V17	6V6GT	HOR. OUTPUT	5	0	18		3	282	880		8	17	0.9	4	285	
V18A	1/2 6SL7	HOR. DRIVE AMP.	1	-1	3.8		2	145	30		3	0.05	0.09	-	-	
V18B	1/2 6SL7	HOR. DISCHARGE	4	-26	30		5	167	18		6	0.02		-	-	
V19	991	REGULATOR	-	-			-	1190			-	1140		-	-	
V20	2F21	MONOSCOPE	PIN NO.		1	2	3	4	5	6	7	8	COLLECTOR CAP			
			DC VOLTAGE		-	0	-600	-900	-800	-800	-	-	280			

Approximate normal output conditions simulated, 75-ohm terminations used.  
 All dc voltages measured to ground, with RCA VoltOhmyst, Jr.  
 Voltages used: filament 6.3 v. ac; line 115 v. ac; power supply 280 v. dc and -3 v. dc.  
 \*Peak to peak, 60 cycle sweep.

Figure 7—Voltage and Waveform Chart



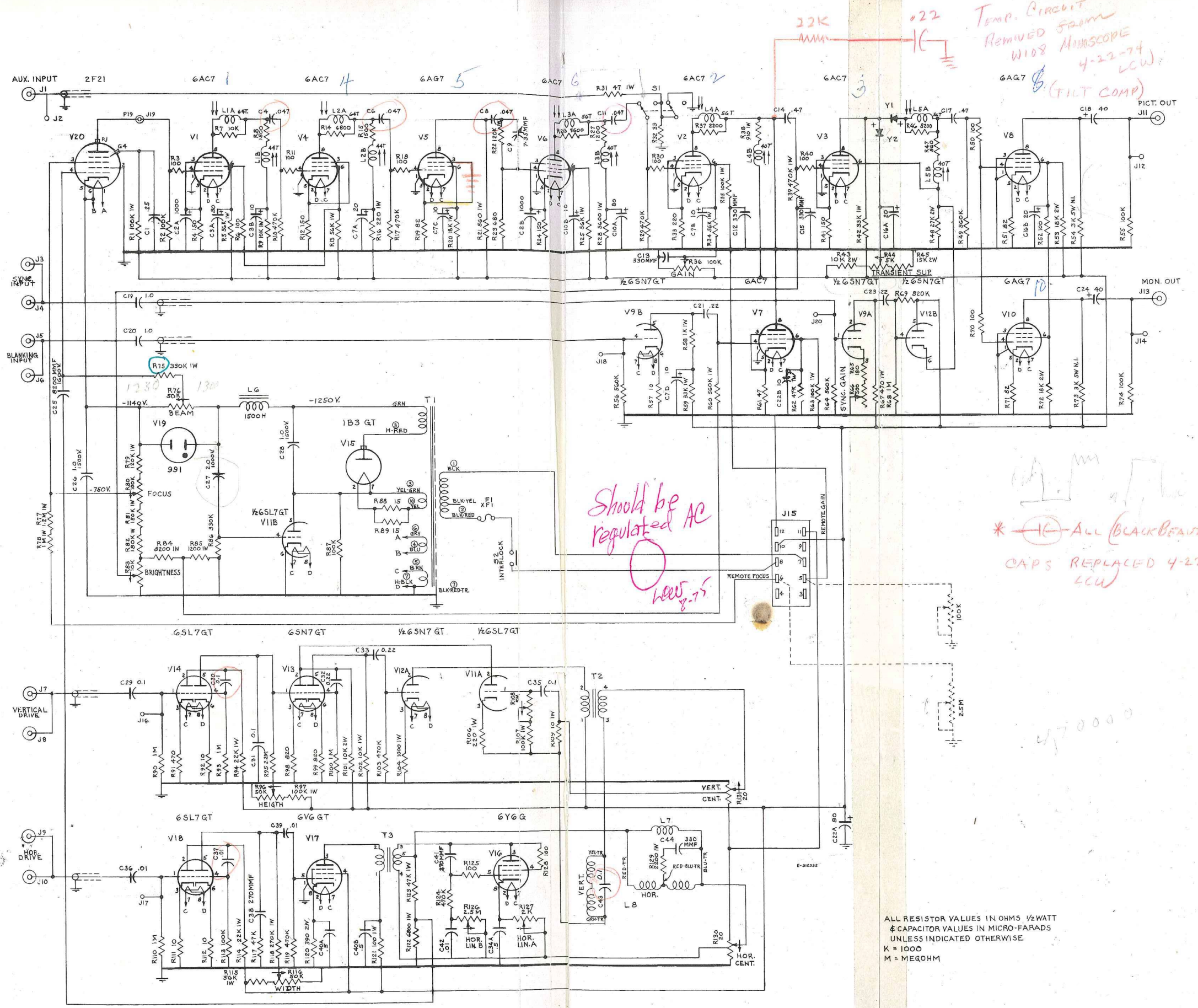

Figure 8—Schematic Diagram, Monoscope Camera





RADIO CORPORATION OF AMERICA  
ENGINEERING PRODUCTS DEPARTMENT CAMDEN, N. J.